



“Industrial, Energy and Developmental Applications for PEM Electrolysis”

March 16, 2011

David Wolff

Regional Sales Manager

860-604-3282

dave.wolff@protonenergy.com

Presentation goals

Illustrate product links, technology pathways and developmental direction

Describe approach to technology development funding

Present ways of dealing with technology and market risk

... Show Proton approach to building a profitable business in a breakthrough technology area

Proton Energy Systems

World leader in PEM electrolysis

- HQ and manufacturing in Wallingford CT
- 75 employees
- ISO 9001:2008 registered
- Commercial systems UL, CSA, CE compliant
- Makes industrial hydrogen **appliances** & systems
- Over 1,600 systems operating in 60 countries



now – solar powered!



PEM Electrolysis is technically well understood, but narrowly mastered

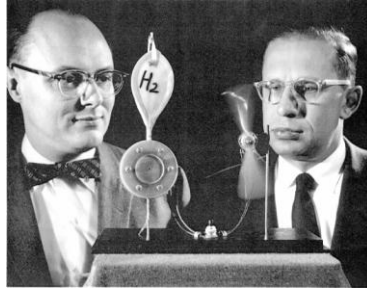

Initial PEM innovators
Grubb & Neidrach,
GE Research, 1955

PEM = SPE

PEM Electrolysis

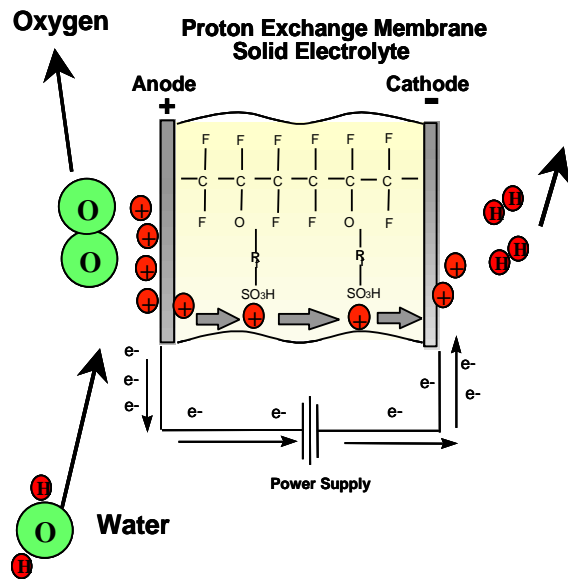

PEM Fuel Cell

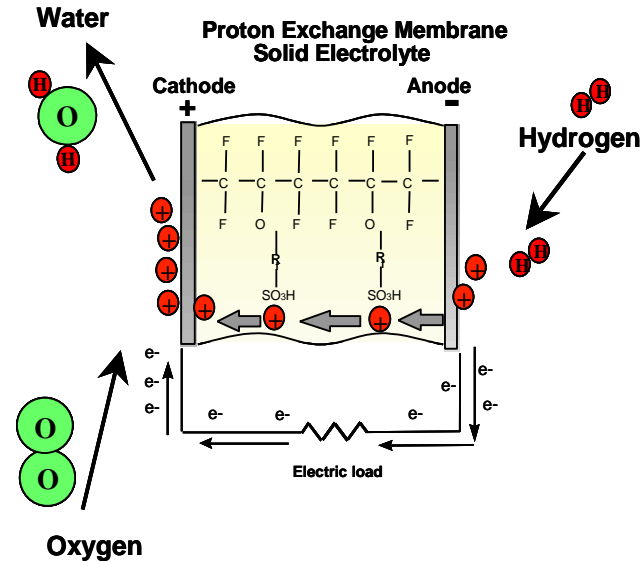

Proton is the world leader at PEM Electrolysis – technical efforts

- Larger capacity systems – based on fueling system requirements
- Higher pressure capability – driven by energy storage needs
- More compact, simpler systems – for reliability and cost leadership
- Explore range of PEM electrolysis capabilities beyond hydrogen generation

Proton Capabilities

- Electrolysis cell stack & system development
- Product development, manufacturing & testing
- System development, customization & integration
- Worldwide sales, 24/7 support, & field service



CELL STACK MANUFACTURING



SYSTEMS DESIGN & MANUFACTURING



ISO 9001
TPS
Lean
5S



CELL STACK R&D



Proton Hydrogen Markets

- Hydrogen as an industrial gas
- Hydrogen as a fuel for transportation
- Hydrogen as an energy storage medium
- Military & Aerospace



Proton Hydrogen Products

Industrial Products

HOGEN hydrogen generators



S Series



H Series



C Series

Lab Gas Generators



StableFlow hydrogen control systems

HOGEN
GC



Energy Products & Projects



Fueling



Backup
Power



Energy Storage

Hydrogen Industrial Markets

- Hydrogen is widely used, fast growing industrial gas
- Major industrial gas consuming industries
 - Power plants
 - Semiconductor manufacturing
 - Silicon semiconductor
 - Compound semiconductor - LED & laser
 - Materials processing
 - Annealing, brazing. P/M, MIM, hermetic, optical fiber
 - Analytical chemistry
 - pharmaceuticals, environmental testing
- Selected alliances drive market acceptance



HOKEN HP systems

- 2,400 psi (165 bar) differential pressure
- 0.6-2.2 kg H₂/day for industrial gas & energy storage
- Field demonstrations underway
- Over 20,000 hr of continuous operation at 2,400 psi
- Stack & system durability demonstrated
- Continued advancement to 5,000 psi for home fueling.

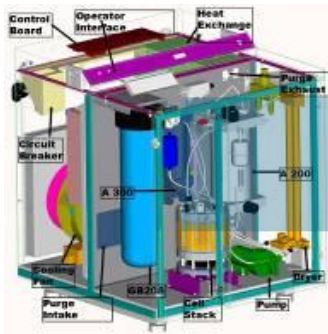

Emerging Market: Hydrogen Fueling



Proton Installations:



Existing



Planned

Early Proton Fueling Demonstrations



Next Generation Stations Need to Get Bigger

Town of Hempstead – Ribbon Cutting 10/21/09



Hydrogen Fueling at Proton

- Considerable experience in fueling stations
 - Over 20 worldwide (up to 65 kg/day)
- FuelGen 65 (kpd) product opens up next generation of fueling opportunities
- Intimately involved in expanding lift truck fueling
- Developing home fueler for introduction in 2011
- Creating fully packaged solution for SunHydro working with Air Products and Linde.

New hydrogen fueling product: FuelGen 65

- Maximum Capacity: 30 Nm³/h H₂ (65 kg/day)
- Now shipping
- 5 times the hydrogen output of the H-Series yet **only 1.5x the foot print.**
- Uses stack platform developed for Navy with Hamilton Sundstrand.
- Entry to higher flow heat treating, food processing & glass manufacturing.



SunHydro Prototype H₂ Fueling Station

- Opened October 15, 2010 at Wallingford, CT HQ
- Packaged ISO container system
- 65 KPD, 350/700 Bar, TIR J2601, J2799

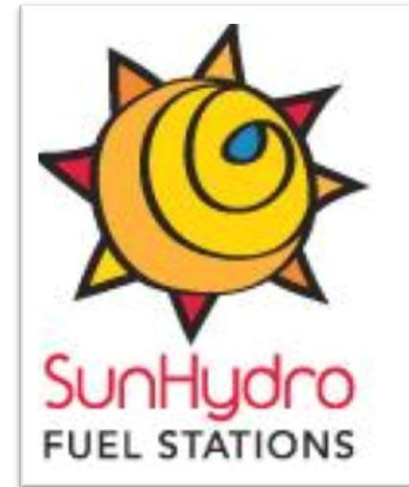

- 3rd party Certified to NFPA 52:2010
- Powered from grid and on-site PV

SunHydro Station Concept

On-site H₂ generation, compression, storage
700/350 Bar dispensing – 40' ISO container



Proposed SunHydro East Coast Hydrogen Highway



- Portland, ME
- Braintree, MA
- Wallingford, CT
- South Hackensack, NJ
- Claymont, DE
- Richmond, Virginia
- Charlotte, NC
- Atlanta & Savannah, GA
- Orlando and Miami, FL



Braintree MA currently scheduled for Q2 2011 opening

Hydrogen Infrastructure Challenges

- Ramp-up
 - Fuel production
 - Storage
 - Transportation
 - End-customer delivery
- Pace installs with parallel ramp-up of related vehicles
- Continuum of options
 - Large, centralized plants
 - Neighborhood / captive fueling stations
 - Home-based fueling

- Traditional Markets
 - Light vehicle fleets
 - Buses
 - Specialized vehicles
- Alternative Markets
 - Materials handling
 - Military / Aerospace
 - Bikes/Motorbikes
 - Marine

Proton focus areas

The practical details...

- Sequence of station buildout is flexible. Next station will likely be in Braintree, MA.
- SunHydro is coordinating the rollout plan with the vehicle OEM deployment plans.
- Firm sites have not been selected for all locations.
- Third party funding will help accelerate development of some sites.
- Need to establish hydrogen demand for the station to assure high utilization.

The second pathway: “home fueling”

- Small-scale hydrogen generation
- Safe system, easy to operate
- $\geq 5,000$ psi (350 bar) dispensing pressure
- Potential integration with renewables
- Simple, low cost
- Small footprint
- Designed for applicable codes & standards
- Introduction expected late 2011

Proton's Home Fueling Pathways

- H₂ generation/compression

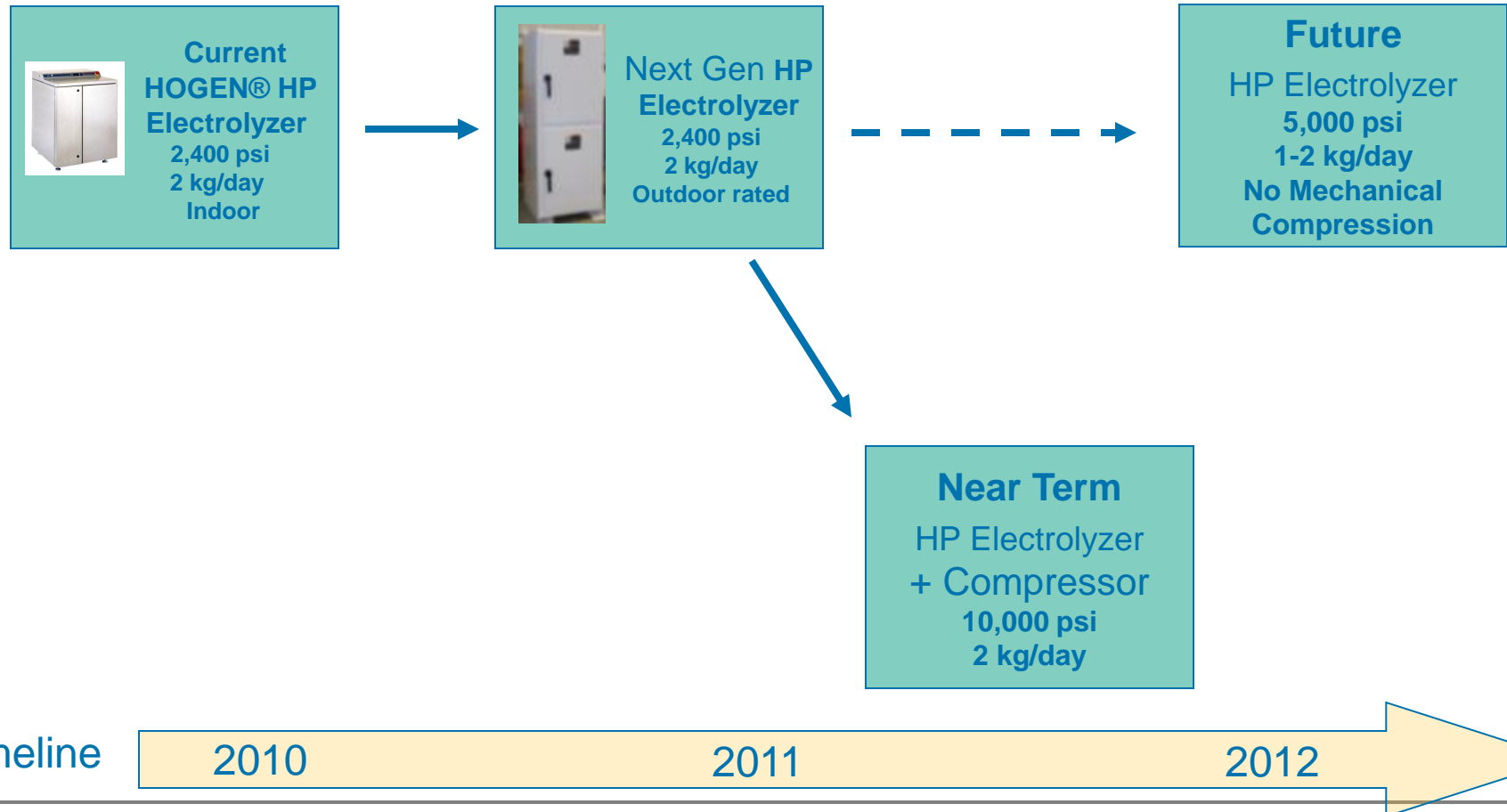

Near Term Fueling System Concept

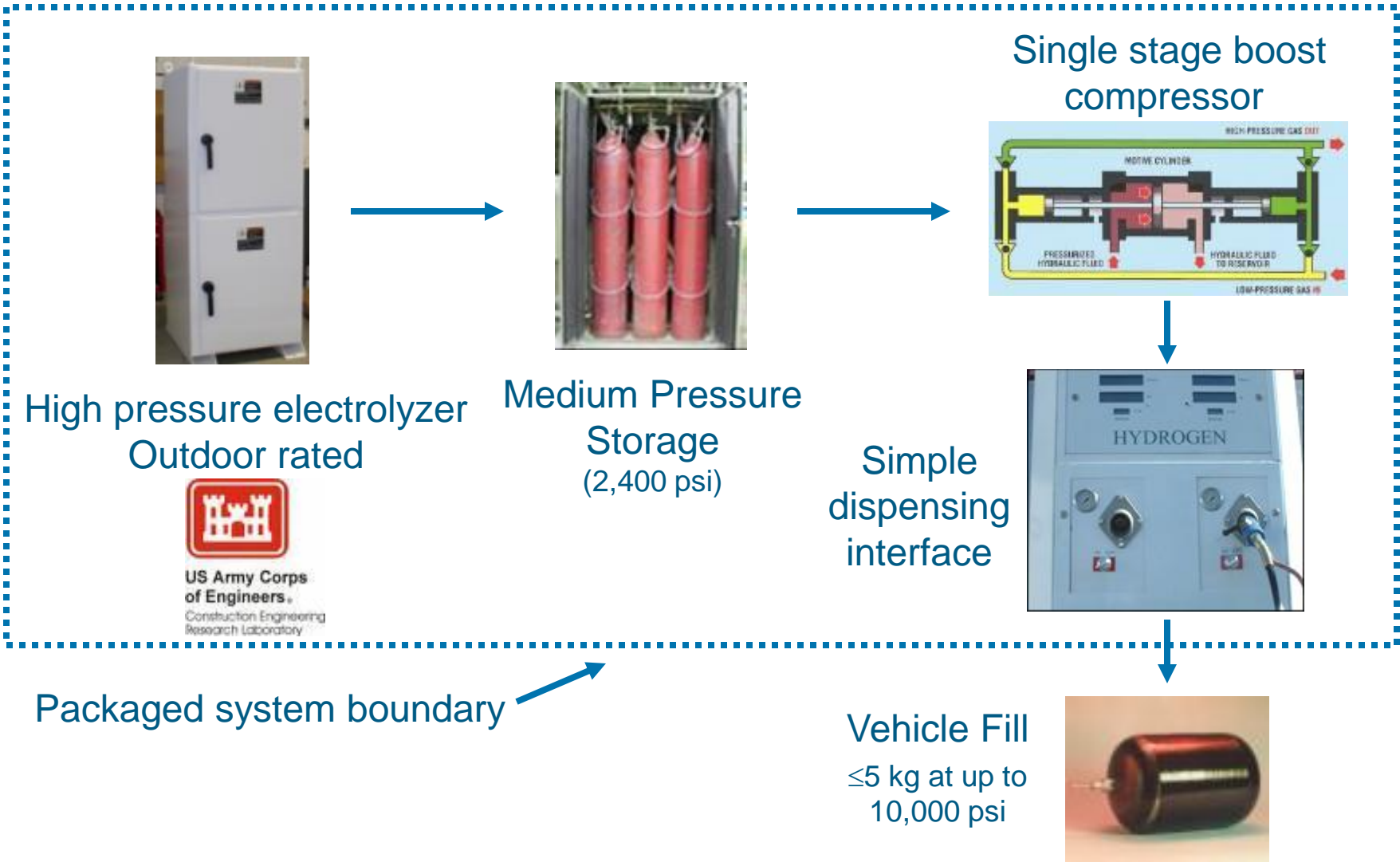

Home Fueler Prototype: currently in testing

- Leverage commercial platform and demonstrated high pressure capability
 - On-site generation for backup power and fueling
- High differential pressure, PEM electrolysis
 - 2400 psi generation: eliminates at least one stage of compression and minimizes storage
- 2+ kilograms per day: matches OEM projections for home demand



Conceptual views for near term and longer-term packaged home fueler systems

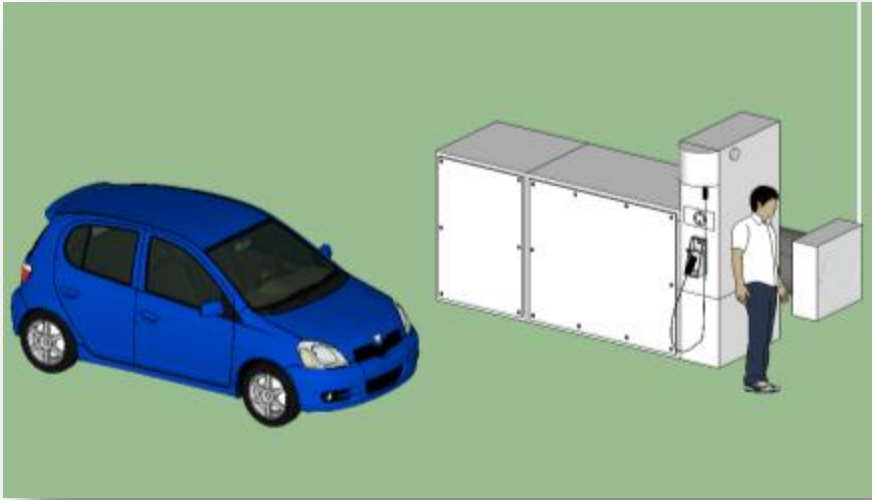

Next Step: Compression free 5,000 psi electrolysis

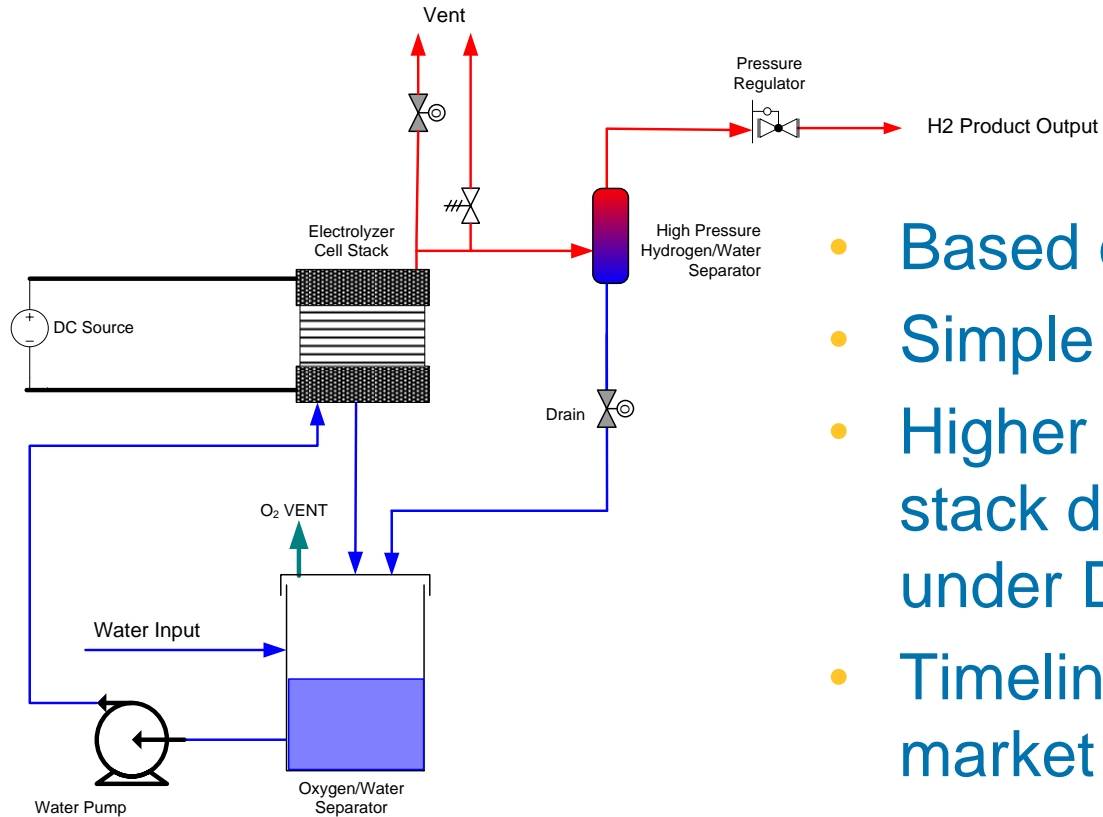

- Based on 2,400 psi platform
- Simple balance-of-plant
- Higher differential pressure stack development initiated under DOE funded program
- Timeline to be driven by market need

Residential Fueling Siting in the U.S.

- Most existing local building code statutes do not mention hydrogen
- No nationalized product listing standards
- Currently, each state or major municipality has its own code
- Adapted from common “model” codes
- Lag between the latest model codes and the codes that are law in the states and municipalities due to:
 - Addition of local content to the model codes by states/municipalities
 - Current state and local codes are often not based on the latest revisions

Fueling Pathway Forward

- Need to align vehicle and station rollout.
- Public needs to experience “commercial-like” fueling stations.
- Permitting and approval needs to become more standardized, and not like a one-off every time.
- Need to create a business case for putting hydrogen at retail stations.
- Subsidies are needed for now, but they need to go away eventually.

Emerging Markets: Backup Power & Energy Storage



Backup Power System Concept Using HOGEN[®] HP High Pressure Electrolyzer

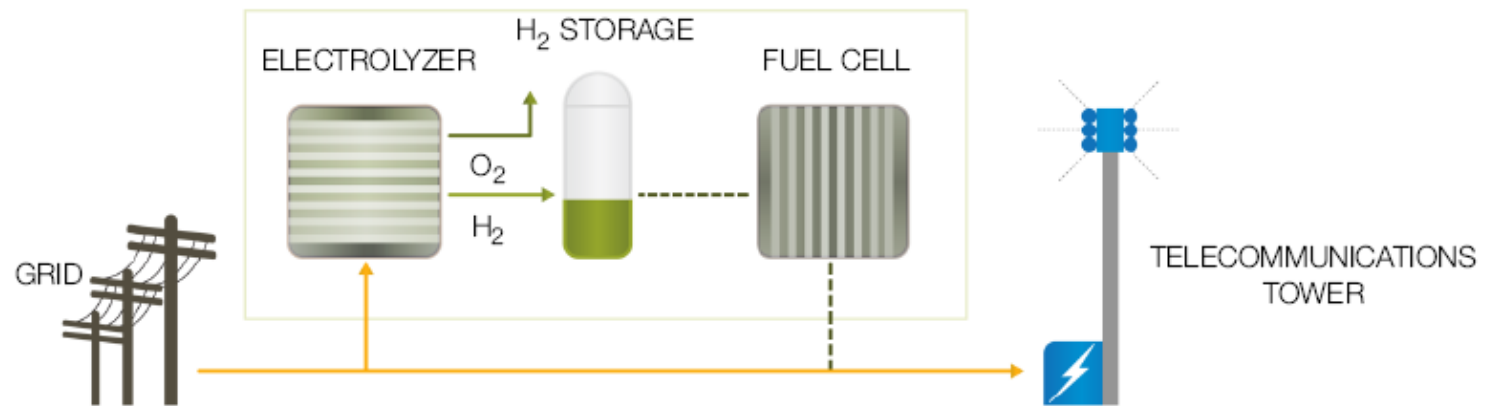

When grid power is available, the HOGEN HP recharges the hydrogen storage.

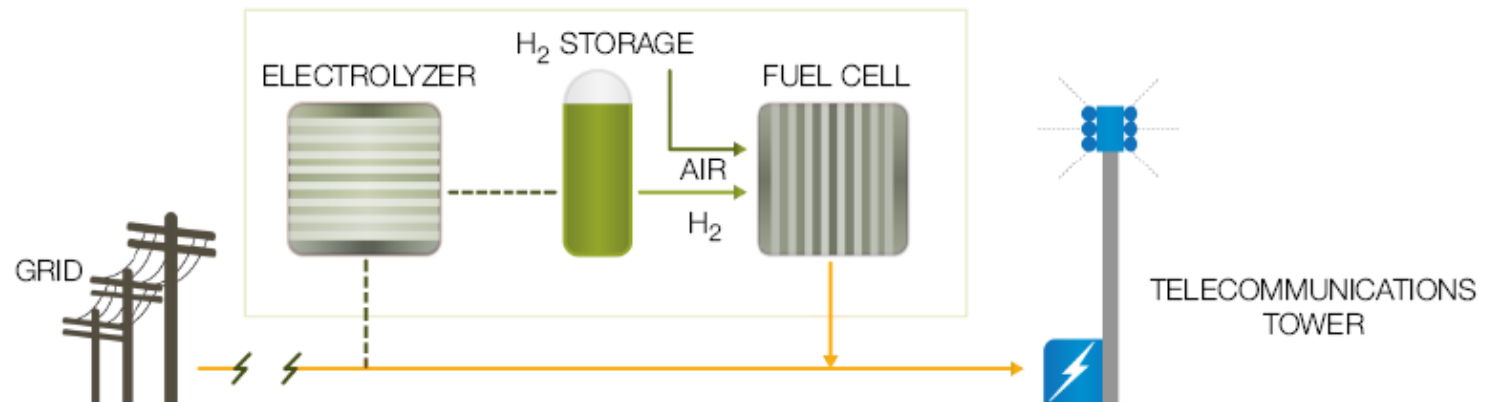

When grid power is lost, the stored hydrogen is directed to a fuel cell, which provides backup power to the load.

Backup Power Demonstrations



Telecom Switching Station



Electric Utility Substation

Renewable Energy Storage Demonstration: Residential Solar Hydrogen Systems



USMMA Solar Hydrogen House
King's Point, NY



Hopewell Project
East Amwell, NJ
Michael Strizki home

Military & Aerospace

Various military and aerospace applications are enabled by PEM electrolyzer technology:

- Unmanned underwater and aerial vehicles
- Remote camp energy storage
- Space based systems – lunar colonies and satellites
- Submarine life support
- Border surveillance

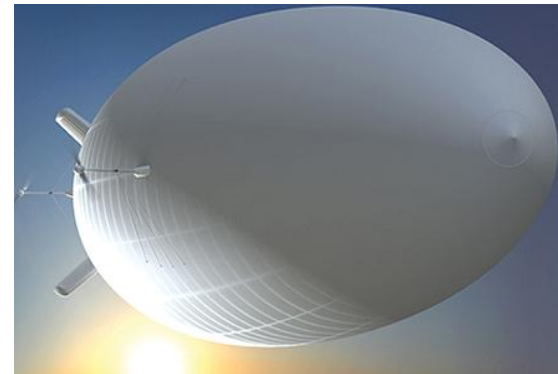

Stratospheric airship concept
with solar regenerative energy storage

Navy Life Support cell stack enables dual use applications for C-Series

- Hamilton Sundstrand chose Proton to develop and manufacture cell stacks for its Navy customers (U.S. and U.K.)
- Proton completed design cycle in 18 months (through MIL-S-901D Shock and MIL-STD-167-1 Vibration qualification testing).
- High reliability designed into this stack platform will help assure high reliability in C-Series product.



Proton PEM cell stack for UK Vanguard subs

PEM electrolyzer technology has a long history of reliability in mission critical applications

Space exploration life support
SSN and SSBN submarine life support

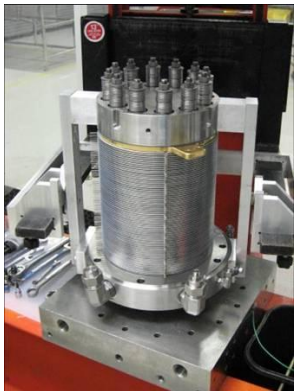

Proton cell stack



Integrated Low Pressure Electrolyzer

Photo courtesy of Hamilton Sundstrand



US and UK subs

UUV Power System Concept with On-Board Recharge

Eliminates high pressure gas transfer during recharge

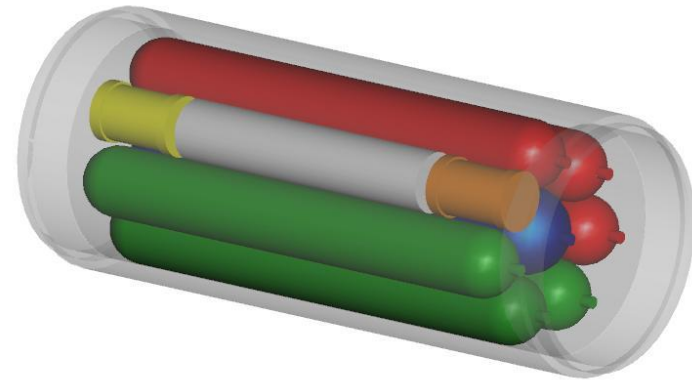
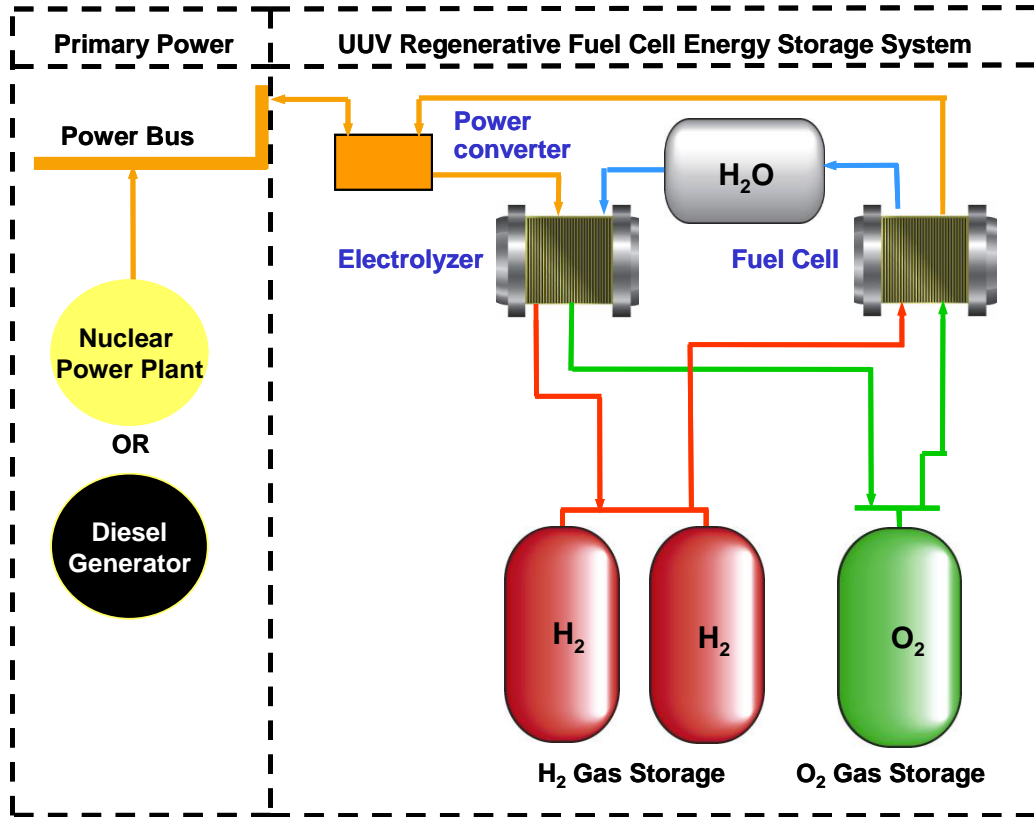

UUV Energy Storage Section

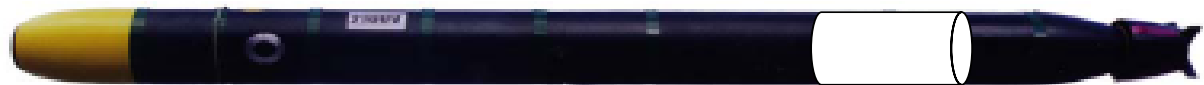

Energy Storage Estimates for 21" MRUUV



21" MRUUV Alternative Propulsion Systems

<u>Chemistry</u>	<u>Energy (kw-hr)</u>	<u>Cycles</u>
• Lead Acid	5.6	>300
• Silver Zinc (Ag Zn)	22.0	15-20
• Lithium Thionyl Chloride (LiSOCl ₂)	96.5	1
• Li Ion Polymer (Predicted)	25.0	>300
• Fuel Cell ???	?	?
• PEM H₂-O₂ RFC	70-100	>1,000

DRFC for High Altitude Platforms

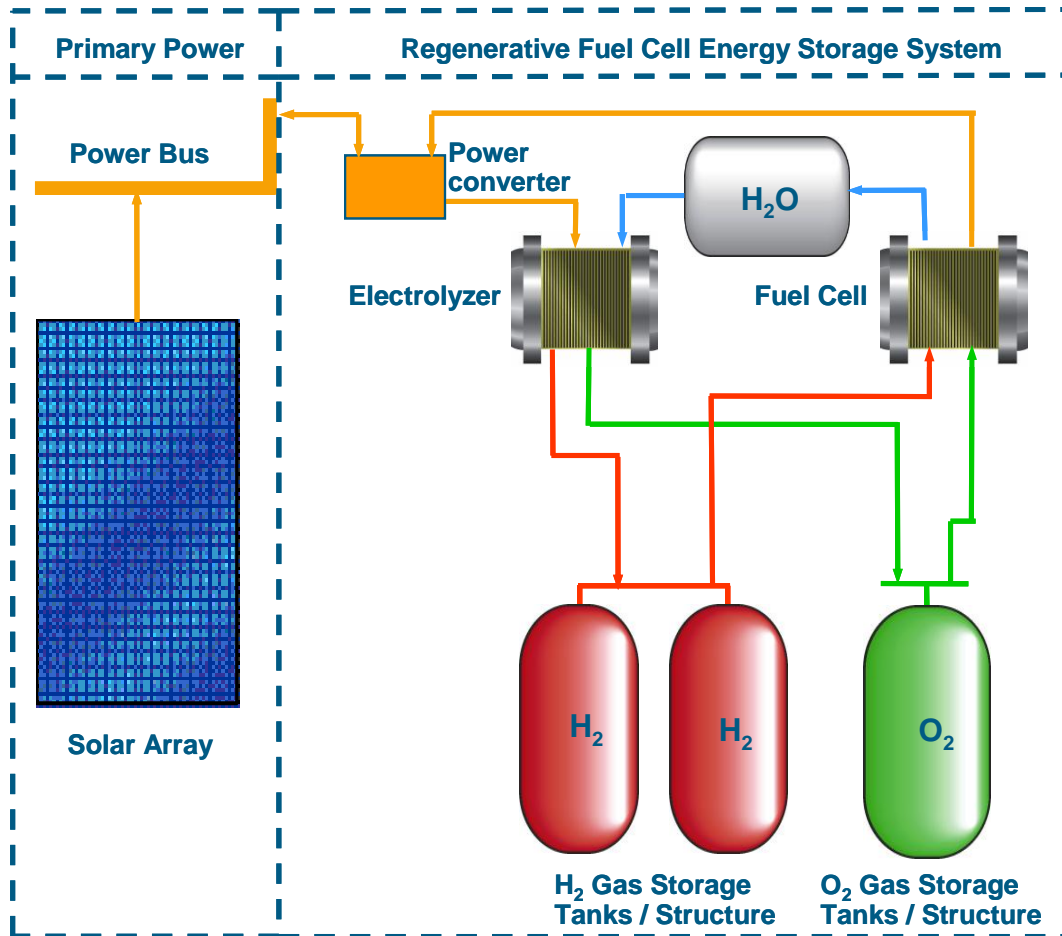

Discrete Regenerative Fuel Cell system



2 kW closed loop DRFC on test
400 psig H₂ / 375 psig O₂

Alternate UPS Concept for Navy Shipboard Application

RFC Packaging Concept to Replace MIL-P-24765 UPS:
> 3X improvement in backup time over incumbent

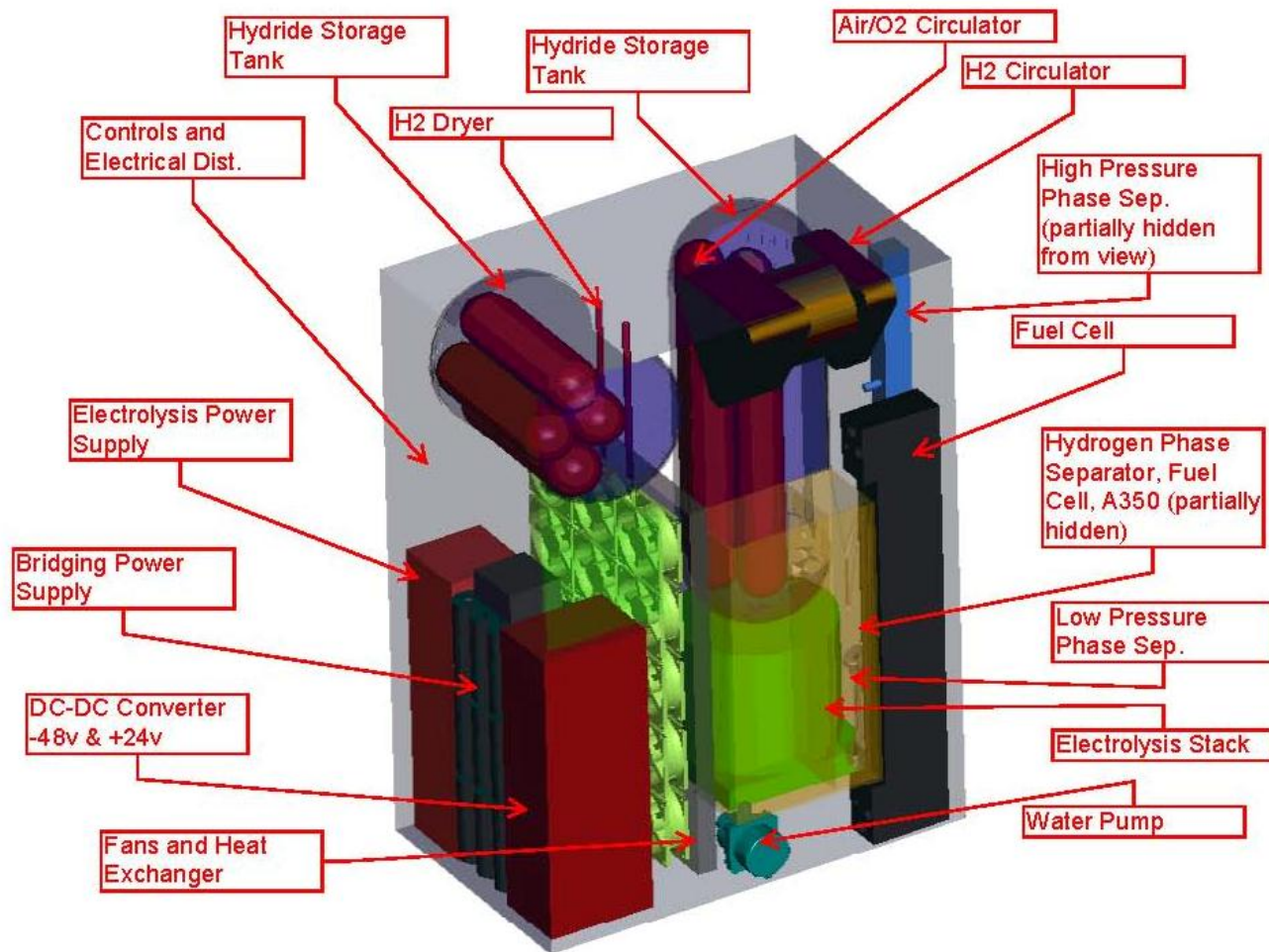

Pathway Forward

- Grow commercial business to a level of sustained profitability.
- Continued development of larger systems and high pressure systems as market conditions dictate.
- Aggressively pursue third party funding to help fund development activities – Government and Industry.
- Broaden our product reach and acceptance more internationally.
- Maintain world leadership in PEM electrolysis technology.

The Hydrogen Education Foundation's Hydrogen Student Design Contest

www.HydrogenContest.org

Sponsored by the U.S. Department of Energy

2011 Sponsors and Supporters



Home

Home

About

2011 Contest

How to Participate

Previous Contests

FAQs

Mailing List

Sponsorship

Contact

2011 Contest: Residential Fueling Rules and Guidelines Now Available!

(Registration Open Until October 15)

The annual Hydrogen Student Design Contest challenges university students to design hydrogen energy applications for real-world use.

Established in 2004 by the Hydrogen Education Foundation, the Contest showcases the talents of students in many disciplines, including engineering, architecture, marketing, and entrepreneurship. Each year, the Contest is administered with the assistance of leaders in government and the hydrogen and fuel cell industries.

[More >>](#)



NATIONAL HYDROGEN ASSOCIATION
HYDROGEN
CONFERENCE & EXPO
FEB. 13-16, 2011 • WASH. DC AREA

GoToWebinar®

Contest
Info Session

Join Us Online
Sept. 21, 3PM ET



Thank you!

Proton industrial products contact:

Dave Wolff Regional Sales Manager
dave.wolff@protonenergy.com 860-604-3282

Proton fueling & energy contact:

Steve Szymanski Business Development Manager
sszymanski@protonenergy.com 203.678-2338